

- (BG)** Инструкция за монтаж и експлоатация
- (EN)** Instruction for installation and use
- (RO)** Instrucțiune de instalare și utilizare
- (SRB)** Uputstvo za ugradnju i upotrebu
- (HR)** Uputstvo za ugradnju i upotrebu
- (BIH)** Uputstvo za ugradnju i upotrebu
- (HU)** Szerelési és kezelési utasítás
- (SLO)** Navodilo za vgradnjo in uporabo
- (GR)** Οδηγισο για την εγκατασταση και τη χρηση
- (MK)** Упатство за вградување и употреба
- (SK)** Návod na montáž a používanie
- (PL)** Instrukcja instalacji i użytkowania
- (P)** Instrução para instalação e uso
- (IT)** Istruzioni per l'installazione e l'uso



- (BG)** Светодиодно (LED) тяло за вграждане
- (EN)** LED spotlights
- (RO)** Corp de iluminat Spot QUAD
- (SRB)** LED Spot lampa QUAD
- (HR)** LED ugradna svjetiljka QUAD
- (BIH)** LED Spot lampa QUAD
- (HU)** LED mélysugárzó QUAD
- (SLO)** LED downlights QUAD
- (GR)** Φωτιστικό LED χωνευτό QUAD
- (MK)** LED Светилки
- (SK)** LED spotvilágítás QUAD
- (PL)** Reflektory LED
- (P)** Holofotes LED
- (IT)** Faretti a LED

Read carefully before installation



WARM WHITE 2700K
NEUTRAL WHITE 4000K

www.elmarkholding.eu

IP20



Model	W	K	lm	lm/W	Beam angle	Size (mm)				
						L	W	H	L1	W1
92Q31240WH	3x12	4000	2700	75lm/W	38°	490	190	145	465	165
92Q31227WH	3x12	2700	2700	75lm/W	38°	490	190	145	465	165
92Q31240DGR	3x12	4000	2700	75lm/W	38°	490	190	145	465	165
92Q31227DGR	3x12	2700	2700	75lm/W	38°	490	190	145	465	165
92Q41240WH	4x12	4000	3600	75lm/W	38°	340	340	145	315	315
92Q41227WH	4x12	2700	3600	75lm/W	38°	340	340	145	315	315
92Q41240DGR	4x12	4000	3600	75lm/W	38°	340	340	145	315	315
92Q41227DGR	4x12	2700	3600	75lm/W	38°	340	340	145	315	315
92Q61240DGR	6x12	4000	5400	75lm/W	38°	490	340	145	465	315
92Q61227DGR	6x12	2700	5400	75lm/W	38°	490	340	145	465	315
92Q61240DGR	6x12	4000	5400	75lm/W	38°	490	340	145	465	315
92Q61227DGR	6x12	2700	5400	75lm/W	38°	490	340	145	465	315

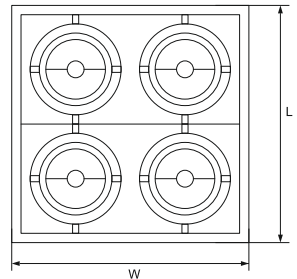
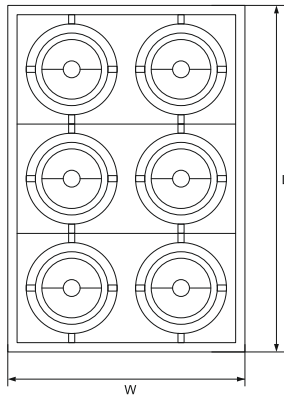
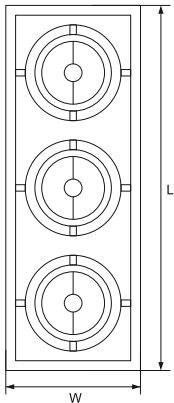
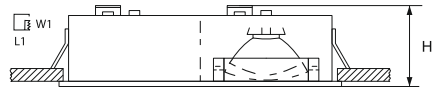
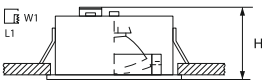

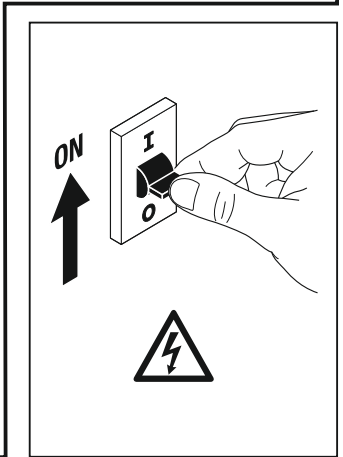
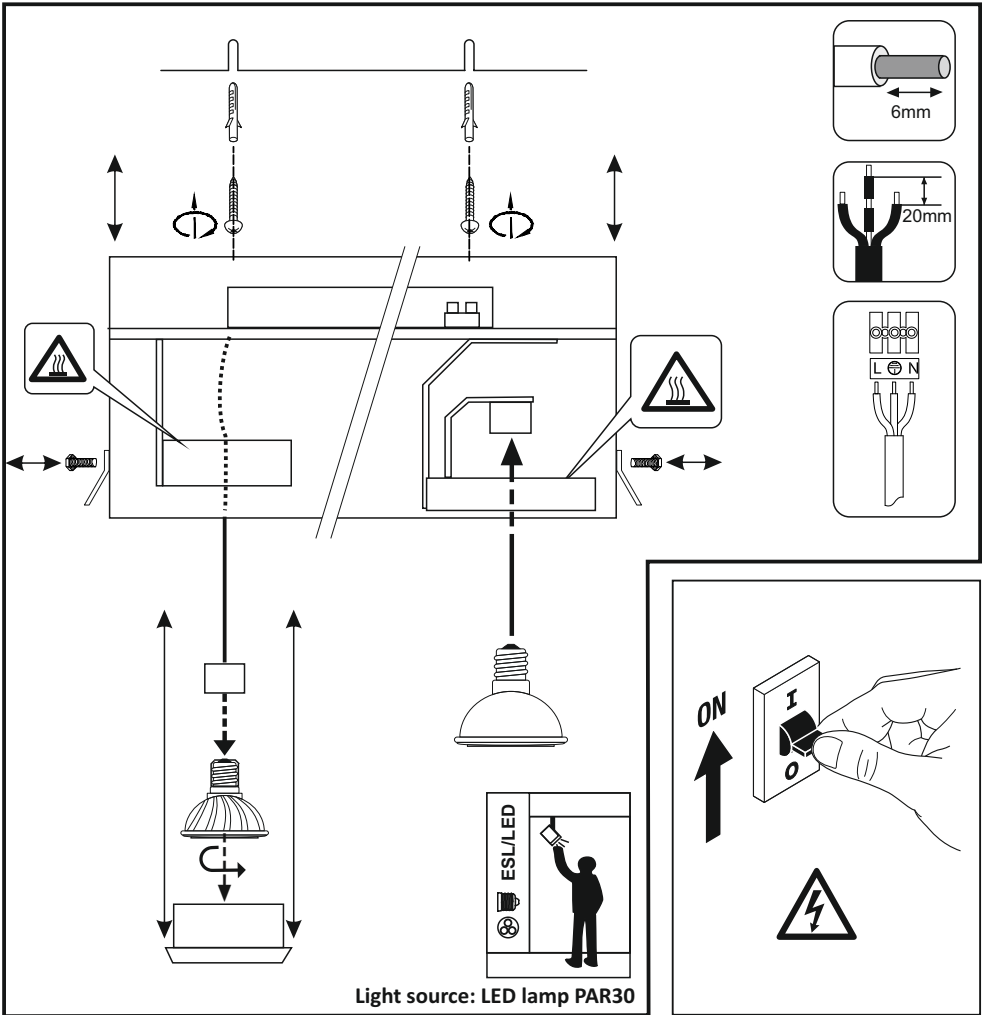
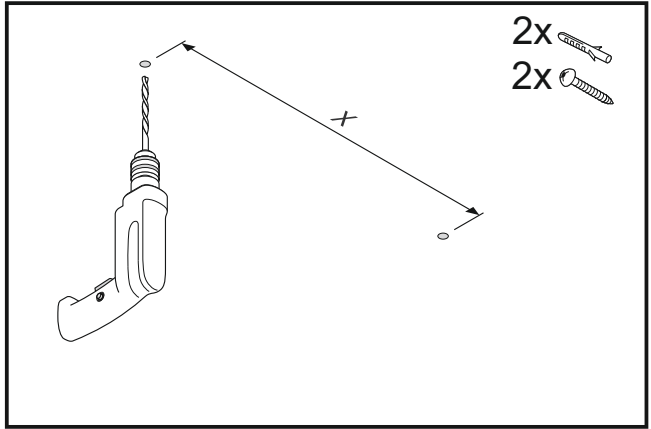
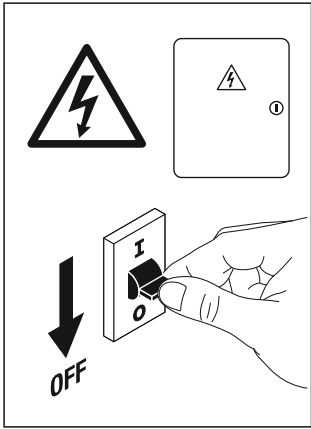

BG - Осветителното тяло трябва да бъде монтирано и въведено в експлоатация единствено от специалист с подходящо електротехническо образование. Преди свързването му към захранващата клема първо се уверете, че няма наранена или липсваща изолация по захранващите проводници. Цветният код на кабелите е черен или кафяв (L) = фаза проводник, син N нулев проводник и жълто-зелен - защитен (зануляващ) проводник - при тела защитени срещу поражение от електрически ток клас 1. Видът на източника на напрежение, както и останалите технически характеристики са посочени в таблица. **EN** - The light fitting must only be mounted and put into operation by a qualified electrician! Make sure that you do not damage any electric cables when you are mounting the light fitting. The colour codes of the wire are the following: black or brown (L) = phase conductor, blue (N) = neutral conductor, and in the case of a light fitting of shock protection class 1: green-yellow =protecting conductor. Only a light source of maximum performance and of the type indicated in the data plate and around the socket can be used for the product. The light fitting must only be mounted and put into operation by a qualified electrician! **D** - Die Montage und Inbetriebsetzung des Leuchtkörpers darf nur von Fachleuten vorgenommen werden! Bei der Montage des Lichtkörpers soll darauf geachtet werden, dass das elektrische Kabel nicht verletzt wird. Die Leitungen sind mit den folgenden Farben versehen: schwarz oder braun (L)=Phasenleiter, blau (N) = Nullleiter, und bei Leuchtkörpern mit Berührungsschutzklasse 1. : grün - gelb = Schutzleiter. **CZ** - Montáž a zprovoznění lampy smí provádět výhradně jenom odborná osoba. Při montáži lampy dejte pozor na to, aby jste náhodou nepoškodil elektrický kabel. Význam používaných barev u kabelů jsou následující: černá, nebo hnědá (L) = fázový vodič, modrá (N) = nulový vodič, u lampy s proti dotykovou ochranou: zele- ná-žlutá = ochranný (uzemnění) vodič. **SL** - Namontovanje osvetlovalnega telesa a jeho uvedenie do prevádzky môže vykonávať len odborník! Pri namontovaní osvetlovalacieho telesa dbajte na to, aby ste neporušili kábel elek-trického vedenia. Farebné označenia vodičov sú nasledovné: čierna, alebo hnedá farba (L) = fazový vodič, modrá (N) = nulový vodič, a v prípade osvetlovalacieho telesa patriaceho do I.triedy ochrany pred nebez-pečným dotyk: zelená-žltá = ochranný vodič. **PL** - Lampa może być zamontowana i uruchomiona tylko przez specjalistę! Przy montowaniu lampy należy uważać, aby nie uszkodzić kabla elektrycznego. Oznakowanie kolorów kabli: czarny lub brązowy (L) = przewód fazowy, niebieski (N) = przewód zerowy i w przypadku lampy I. ochrony kontaktu: zielono-żółty =przewód ochronny. **HU** - A lámpatest felszerelését és üzembe helyezését csak szakember végezheti! A lámpatest felszerelésénél vigyázzon arra, hogy ne sértsen meg elektromos ká-belt. A vezetéknek színjelölése a következők: fekete vagy barna (L) = fázisvezető, kék (N) = nulla vezetető, és 1. érintésvédelmi lámpatest esetén: zöld-sárga védővezető. **SK** - Montiranje in stavljanje svetilke v obrat sme izvrševati le strokovnjak! Pri montiranju svetilke pazite da ne poškodujete električnega kabla. Barvna zaznamovanja vod so naslednja: črna ali rjava (L) = fazni vod, modra (N) = nevtralni vod, in v primeru svetilke z zaščito pred dotikom: zelena- rumena = zaščitni vod. **BIH** - Montažu rasvjetnog tijela i stavljanje u pogon može izvršiti samo stručna osoba! Kod montaže rasvjetnog tijela pazite da ne oštetite električni kábel. Označavanje kablova prema bojama: crna ili smeđa (L)= faza, plava (N) = nula, i kod rasvjetnog tijela sa 1. stupnjem zaštite zeleno-žuta = uzemljenje. **SRB** - Montažu lampe i stavljanje u pogon može izvršiti samo stručna osoba. Prilikom montaže lampe pazite da ne oštetite kábel. Značenje kablova prema bojama: crna ili smeđa (L)= faza, plava (N) = nula, i kod lampi sa 1 štenom zaštite zeleno-žuta = uzemljenje. **RO** - Montarea și punerea în funcțiune a corpului de iluminat poate fi realizată doar de personal de specialitate! La montarea corpului de iluminat urmăriți să nu deteriorați cablurile electrice. Marcarea cu colori a cablurilor este următoarea: negru sau maro (L) = cablu de fază, albastru (N) = cablul nul, și în cazul corpului de iluminat cu clasa de împământare I.: verde-galben = împământarea. **GR** - Η τοποθέτηση και οι ρυθμίσεις πρέπει να γίνονται μόνο από ειδικό. Στην τοποθέτηση πρέπει να προσέξετε να μην προκαλέσετε φθορές στο καλώδιο. Το χρώμα των καλωδίων είναι ως εξής: μαύρο ή καφέ (L) = φάση, μπλε (N) = ουδέτερο, και σε περίπτωση φωτιστικών με προστασία ηλεκτροπληξίας κλάσης 1: κίτρινο-πράσινο = καλώδιο προστασίας; **IT** - Per la tua sicurezza, l'installazione e la messa a punto vengono eseguite solo da uno specialista! **HR** - Za vašu sigurnost, instalacije i ugađanje izvodi samo stručna osoba! **MK** - Za vašu bezbednost, instalacija i podesuвање се изведува само од специјалиста! **PL** - Ze względów bezpieczeństwa instalację i strojenie wykonuje tylko specjalista! **P** - Para sua segurança, a instalação e o ajuste são realizados apenas por um especialista!



Dowlight Spot



Linear

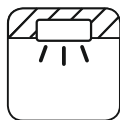

Panel



Surface



DampProof



HighBay



Floodlight

RoHS



EAC



3+0
standard
+extended

3 YEAR TOTAL
WARRANTY